

# BLOWER ORDER: FAX TO 713-675-6433

NAME \_\_\_\_\_ TITLE \_\_\_\_\_

COMPANY \_\_\_\_\_

CONTACT PHONE \_\_\_\_\_ EXTENSION \_\_\_\_\_

E-MAIL ADDRESS \_\_\_\_\_

BLOWER MOUNTS ON \_\_\_\_\_

## STANDARD MOTOR BLOWER MODEL: 200328 Standard Steel 15 HP

Manufactured by Gulf Electroquip

### PARTS DESCRIPTION

(Check ALL PARTS or INDIVIDUAL PARTS)

- 15 HP MOTOR TEFC/XP CAST IRON  
CONSTRUCTION 3,600 RPM, 575 VOLTS,  
3-PHASE, AC, 60HZ, UL CERTIFIED -  
"XP" RATED FOR CL 1 GRP D, DIV 2 MOTOR
- 12" A-STYLE IMPELLER - MILD STEEL
- A-STYLE HOUSING WITH GASKET MILD STEEL
- A-STYLE INLET - MILD STEEL

### PAINT COLOR SELECTION (Choose ONE)

- |   |  |
|---|--|
| <input type="checkbox"/>  LIGHT BLUE | <input type="checkbox"/>  MEDIUM BLUE   |
| <input type="checkbox"/>  DARK BLUE  | <input type="checkbox"/>  RED           |
| <input type="checkbox"/>  GE GRAY    | <input type="checkbox"/>  MEDIUM GRAY   |
| <input type="checkbox"/>  BLACK      | <input type="checkbox"/>  SAFETY YELLOW |

OR PRIMER ONLY   RED   GRAY

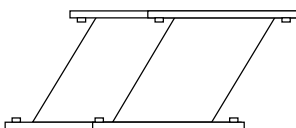

OFFSET FLANGE

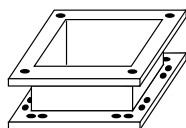

ADAPTER FLANGE

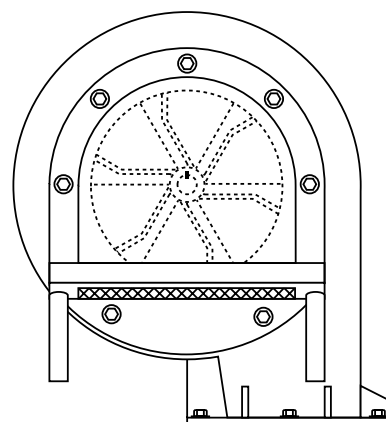
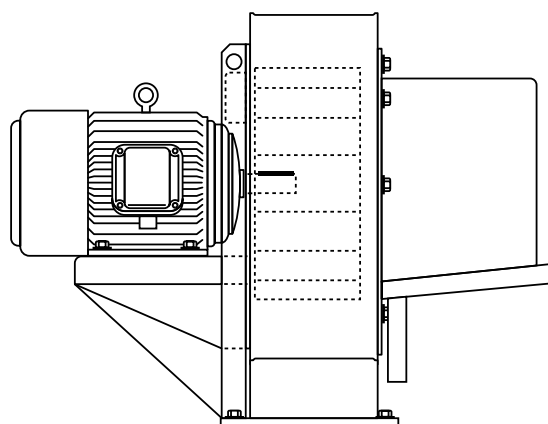

24-HR Phone 713-675-2525 • E-Mail: [parts@gulfelectroquip.com](mailto:parts@gulfelectroquip.com) • [www.gulfelectroquip.com](http://www.gulfelectroquip.com)



**GULF ELECTROQUIP**  
ELECTRICAL MOTORS AND GENERATORS

**PARTS  
COUNTER**